

Main Circuit / Dual USB UART

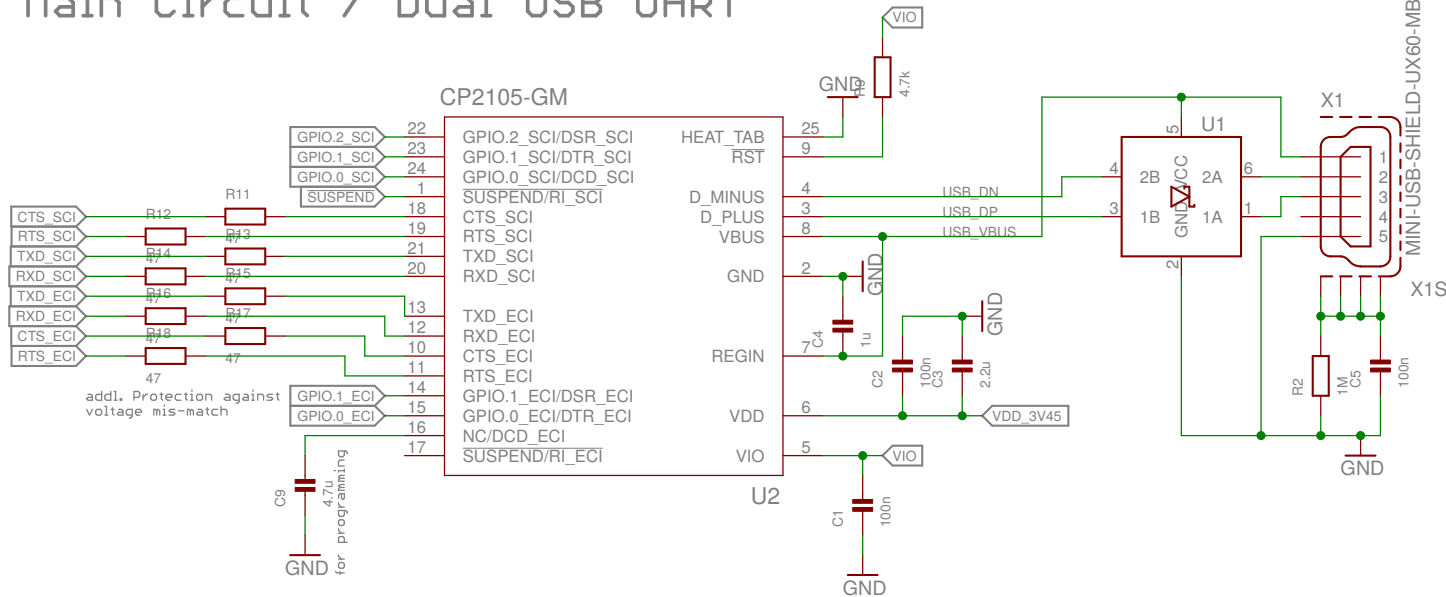

Voltage + GPIO Headers

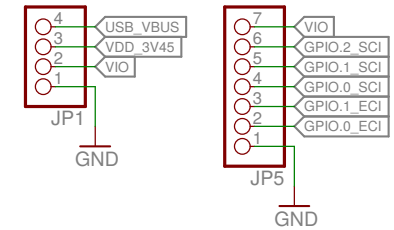

UART Headers

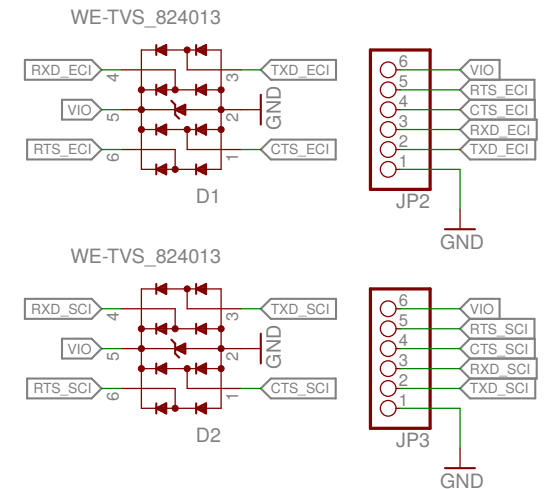

JP2/JP3 Pin 6 is either input (JP4 open) or output (JP4 closed)

Power Supply

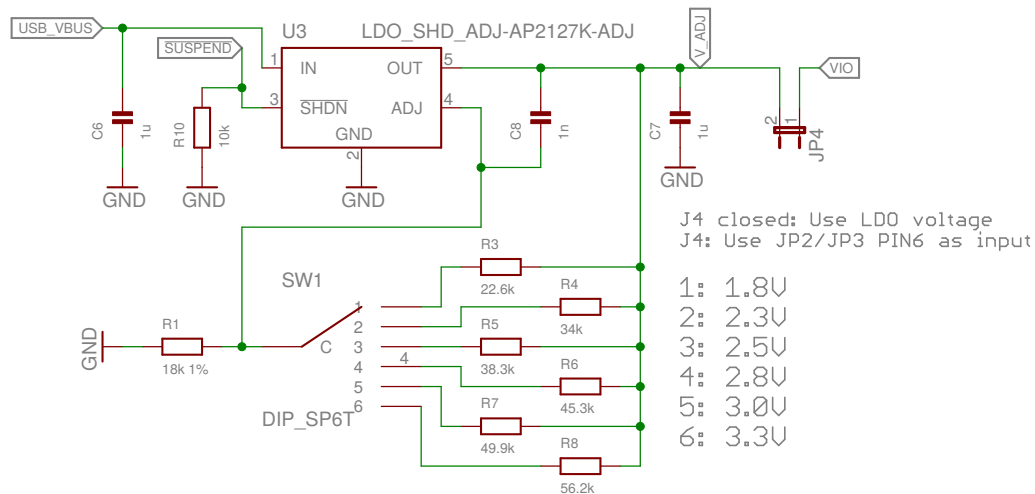

Multi-Voltage UART

TITLE: mv-uart

Document Number: (C) 2016 Harald Welte
 CC-BY-SA

REV:
 v1

Date: 09.10.16 03:14

Sheet: 1/1